

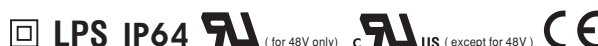

■ Features :

- Universal AC input / Full range
- Protections: Short circuit / Over current / Over voltage
- Cooling by free air convection
- Built-in constant current limiting circuit with adjustable OCP level
- Optional dimming function : 1.1~10VDC (D type) or PWM (P type) controlled
- Fully isolated plastic case with IP64 level
- Class II power unit, no FG
- Class 2 power unit
- Pass LPS
- Suitable for LED lighting and moving sign applications (Note.8)
- 100% full load burn-in test
- Low cost
- 2 years warranty

SPECIFICATION



| MODEL | | ELN-30-5 | ELN-30-9 | ELN-30-12 | ELN-30-15 | ELN-30-24 | ELN-30-27 | ELN-30-48 | | | |
|---------------------|--|--|-------------|--------------|--------------|--------------|--------------|--------------|----------|------------|----------|
| OUTPUT | DC VOLTAGE | 5V | 9V | 12V | 15V | 24V | 27V | 48V | | | |
| | LED OPERATION VOLTAGE Note.7 | 3 ~ 5V | 3 ~ 9V | 3 ~ 12V | 3 ~ 15V | 3 ~ 24V | 3 ~ 27V | 3 ~ 48V | | | |
| | RATED CURRENT | 5A | 3.4A | 2.5A | 2A | 1.25A | 1.12A | 0.63A | | | |
| | CURRENT RANGE | 0 ~ 5A | 0 ~ 3.4A | 0 ~ 2.5A | 0 ~ 2A | 0 ~ 1.25A | 0 ~ 1.12A | 0 ~ 0.63A | | | |
| | RATED POWER | 25W | 30.6W | 30W | 30W | 30W | 30.24W | 30.24W | | | |
| | RIPPLE & NOISE (max.) Note.2 | 80mVp-p | 100mVp-p | 120mVp-p | 120mVp-p | 150mVp-p | 150mVp-p | 250mVp-p | | | |
| | VOLTAGE ADJ. RANGE | 4.5 ~ 5.5V | 8.7 ~ 10.5V | 10.8 ~ 13.2V | 13.5 ~ 16.5V | 21.6 ~ 26.4V | 24.3 ~ 29.7V | 43.2 ~ 52.8V | | | |
| | Can be adjusted by internal potentiometer SVR1 | | | | | | | | | | |
| | CURRENT ADJ. RANGE | -25% ~ 3%. Can be adjusted by internal potentiometer SVR2 | | | | | | | | | |
| | VOLTAGE TOLERANCE Note.3 | ±5.0% | | | | | | | | | |
| | LINE REGULATION | ±1.0% | | | | | | | | | |
| | LOAD REGULATION | ±2.0% | | | | | | | | | |
| | SETUP, RISE TIME Note.6 | 500ms, 80ms / 230VAC 1000ms, 80ms / 115VAC at full load | | | | | | | | | |
| HOLD UP TIME (Typ.) | 50ms/230VAC 16ms/115VAC at full load | | | | | | | | | | |
| INPUT | VOLTAGE RANGE Note.4 | 90 ~ 264VAC | | 127 ~ 370VDC | | | | | | | |
| | FREQUENCY RANGE | 47 ~ 63Hz | | | | | | | | | |
| | EFFICIENCY (Typ.) | 75% | 80% | 82% | 82% | 85% | 85% | 87% | | | |
| | AC CURRENT (Typ.) | 0.75A/115VAC | | 0.48A/230VAC | | | | | | | |
| | INRUSH CURRENT (Typ.) | COLD START 55A(twidth=465µs measured at 50% Ipeak) at 230VAC | | | | | | | | | |
| | MAX. No. of PSUs on 16A CIRCUIT BREAKER | 4 units (circuit breaker of type B) / 8 units (circuit breaker of type C) at 230VAC | | | | | | | | | |
| LEAKAGE CURRENT | 0.25mA / 240VAC | | | | | | | | | | |
| PROTECTION | OVER CURRENT | 95 ~ 110% | | | | | | | | | |
| | Protection type : Constant current limiting, recovers automatically after fault condition is removed | | | | | | | | | | |
| OVER VOLTAGE | 5.75 ~ 6.75V | | 11 ~ 13.5V | | 13.8 ~ 16V | | 17.5 ~ 21V | | 28 ~ 32V | 31 ~ 36.4V | 54 ~ 60V |
| | Protection type : Shut down o/p voltage, re-power on to recover | | | | | | | | | | |
| FUNCTION | DIMMING CONTROL (OPTIONAL) | 1.1 ~ 10VDC or PWM signal : 100Hz ~ 3KHz | | | | | | | | | |
| ENVIRONMENT | WORKING TEMP. | -20 ~ +60°C (Refer to "Derating Curve") | | | | | | | | | |
| | WORKING HUMIDITY | 20 ~ 90% RH non-condensing | | | | | | | | | |
| | STORAGE TEMP., HUMIDITY | -40 ~ +80°C, 10 ~ 95% RH | | | | | | | | | |
| | TEMP. COEFFICIENT | ±0.03%/°C (0 ~ 50°C) | | | | | | | | | |
| VIBRATION | 10 ~ 500Hz, 2G 10min./1cycle, period for 60min. each along X, Y, Z axes | | | | | | | | | | |
| SAFETY & EMC | SAFETY STANDARDS | UL1310, CAN/CSA C22.2 No. 223-M91(except for 48V), IP64 approved ; design refer to TUV EN60950-1 | | | | | | | | | |
| | WITHSTAND VOLTAGE | I/P-O/P:3KVAC | | | | | | | | | |
| | ISOLATION RESISTANCE | I/P-O/P:>100M Ohms / 500VDC / 25°C/ 70% RH | | | | | | | | | |
| | EMC EMISSION | Compliance to EN55022 (CISPR22) Class B, EN61000-3-2 Class A, EN61000-3-3 | | | | | | | | | |
| | EMC IMMUNITY | Compliance to EN61000-4-2,3,4,5,6,8,11, EN55024, light industry level, criteria A | | | | | | | | | |
| OTHERS | MTBF | 628.3Khrs min. MIL-HDBK-217F (25°C) | | | | | | | | | |
| | DIMENSION | 145*47*30mm (L*W*H) | | | | | | | | | |
| | PACKING | 0.26Kg; 60pcs/16.6Kg/1.25CUFT | | | | | | | | | |
| NOTE | <ol style="list-style-type: none"> 1. All parameters NOT specially mentioned are measured at 230VAC input, rated load and 25°C of ambient temperature. 2. Ripple & noise are measured at 20MHz of bandwidth by using a 12" twisted pair-wire terminated with a 0.1uf & 47uf parallel capacitor. 3. Tolerance : includes set up tolerance, line regulation and load regulation. 4. Derating may be needed under low input voltage. Please check the static characteristics for more details. 5. The power supply is considered as a component that will be operated in combination with final equipment. Since EMC performance will be affected by the complete installation, the final equipment manufacturers must re-qualify EMC Directive on the complete installation again. 6. Length of set up time is measured at first cold start. Turning ON/OFF the power supply may lead to increase of the set up time. 7. Constant current operation region is within the specified output voltage range above. This is the suitable operation region for LED related applications. 8. The unit might not be suitable for lighting applications in EU countries. Please check with your local authorities for the possible use of the unit. | | | | | | | | | | |

Mechanical Specification

Case No.964A Unit:mm

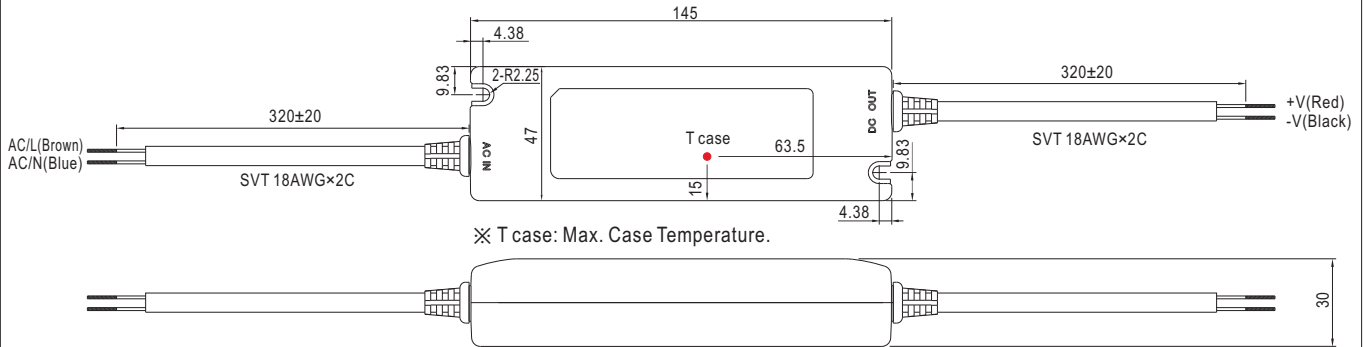

※ T case: Max. Case Temperature.

OUTPUT(with optional dimming function)

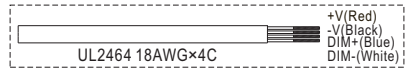

Output voltage and current adjustment : remove the upper case and adjust through SVR1 & SVR2 shown in the diagram.

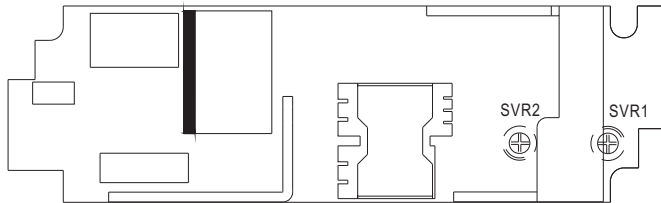

| | |
|------|---------------------------|
| SVR1 | Output voltage adjustment |
| SVR2 | Output current adjustment |

Block Diagram

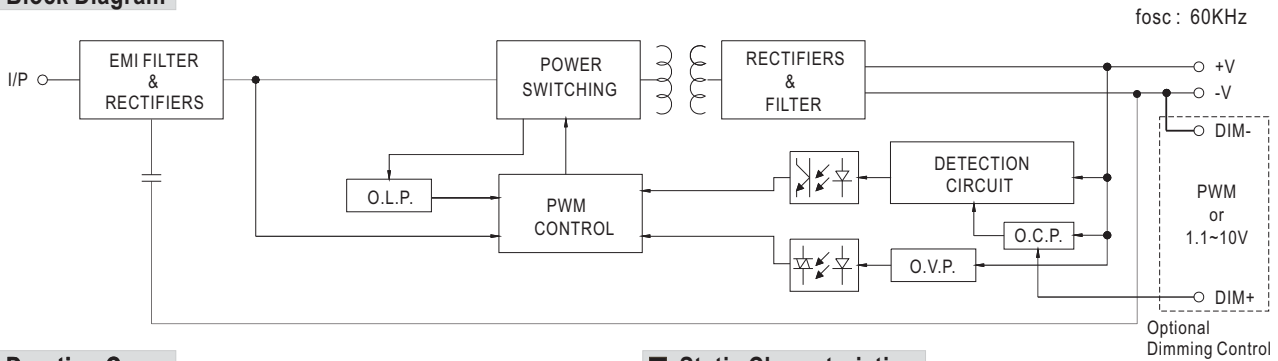

Derating Curve

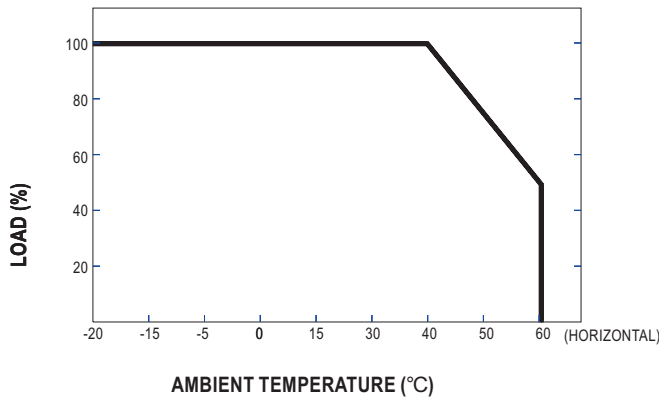

Static Characteristics

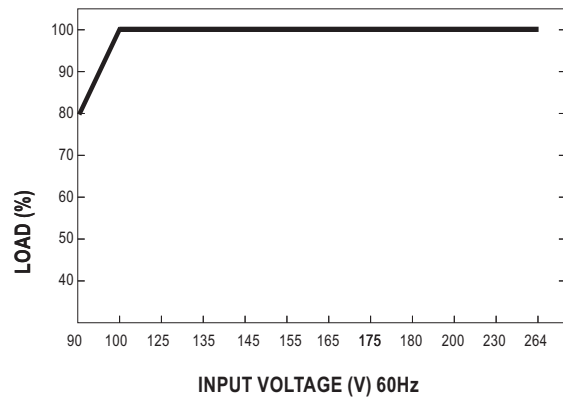

■ Dimming Control (Optional)

Level of output current can be adjusted through the dimming control function.

When there is no signal sending to the control wires (open circuit between the two control wires), the power supply unit will operate as 0V (D-type) or 0% duty (P-type) of input signal and hence the output current will be zero.

(1) 1.1~10V (D type, & : ELN-30-12D)

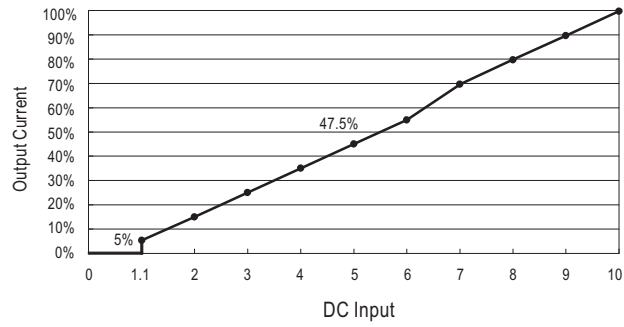
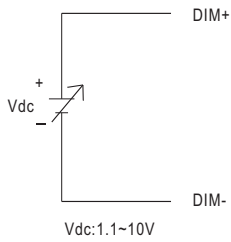

(2) PWM (P type, & : ELN-30-12P)

